

EdilisOFLEX

FLESSIBILE COIBENTATO
INSULATED FLEXIBLE LINER



EdiISO FLEX

A RICHIESTA - ON REQUEST



NEW!

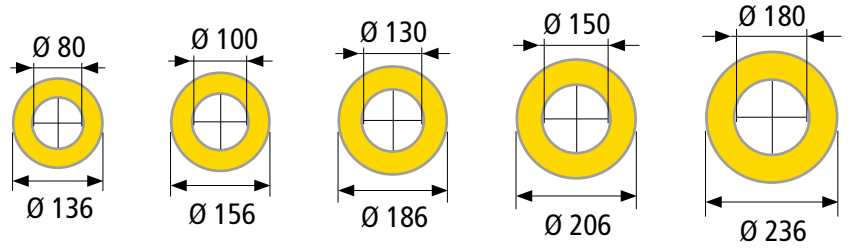

EIKDPISO + Øi



Flessibile coibentato
Insulated flexible



- ✓ Standard
- ✓ Pressione
Pressure
- ✓ Condensazione
Condensation



EIKGMISO + Øi



Giunto flex rigido maschio (N1)
Flexadapter to rigid male (N1)

EIKMXISO + Øi



Giunto flex rigido femmina con invito interno anticondensa (N1)
Flexadapter to rigid female with condensate diverter (N1)



EIKKITISO + Øi



**PRESSIONE
PRESSURE
200 Pa**

Giunto flex 200 Pa rigido maschio (P1)
Flexadapter 200 Pa to rigid male (P1)



Fascetta di chiusura inclusa
Locking band included

FLESSIBILE COIBENTATO - INSULATED FLEXIBLE LINER

Pressione / Pressure T200 P1 W V2 L50010 O con guarnizione / with seal 200 Pa
 Depressione / Negative pressure T600 N1 W V2 L50010 G senza guarnizione / without seal



- Peso massimo 50 kg per un collare tubolare (fig. 1) e 85 kg aggiungendo una piastra intermedia con coppia supporto (fig. 2).
- Prima di effettuare l'intubamento, dopo aver avvitato il giunto, mettere i rivetti sulla parete esterna per creare il collegamento meccanico tra le due pareti (sono previsti 3 fori Ø 4 mm).
- Lo spazio circolare tra ISOFLEX e il condotto esistente deve essere libero e ventilato (senza isolamento aggiuntivo).
- Maximum weight 50 kg for a tubular collar (fig. 1) and 85 kg by adding an intermediate anchor plate with a pair of cantilever brackets (fig. 2).
- Before ducting, after having screwed the joint, put the rivets on the external wall to create the mechanical connection between the two walls (they are provided 3 holes Ø 4 mm).
- The circular space between ISOFLEX and the existing duct must be free and ventilated (without additional insulation).

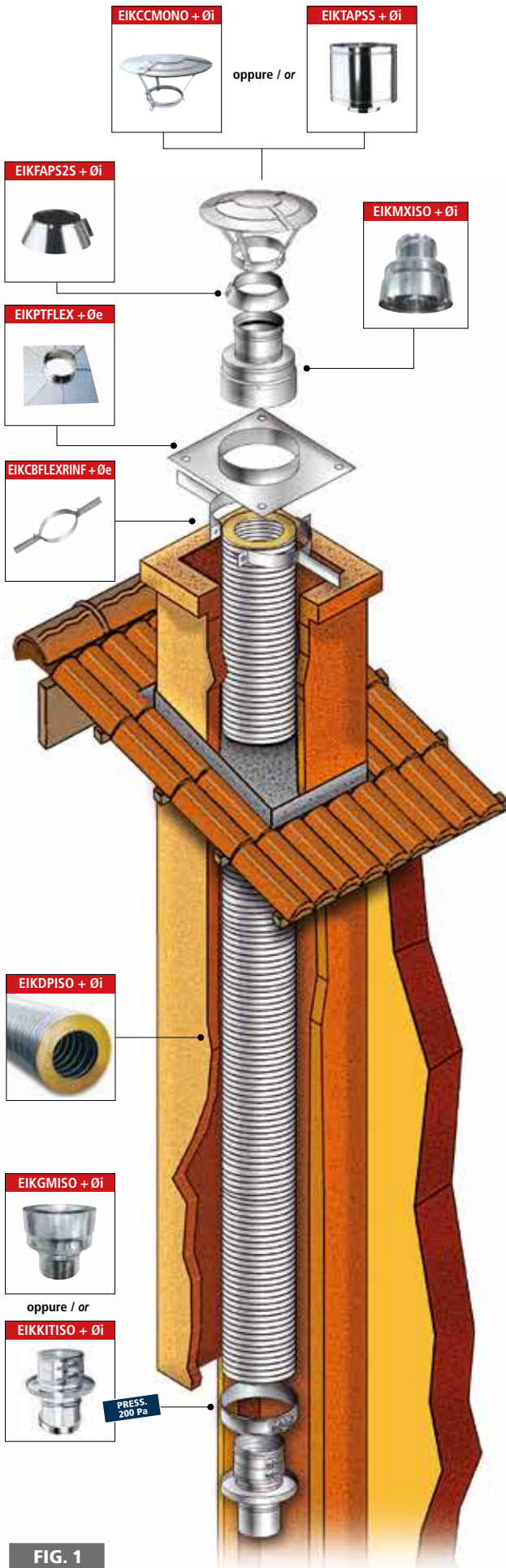

FIG. 1

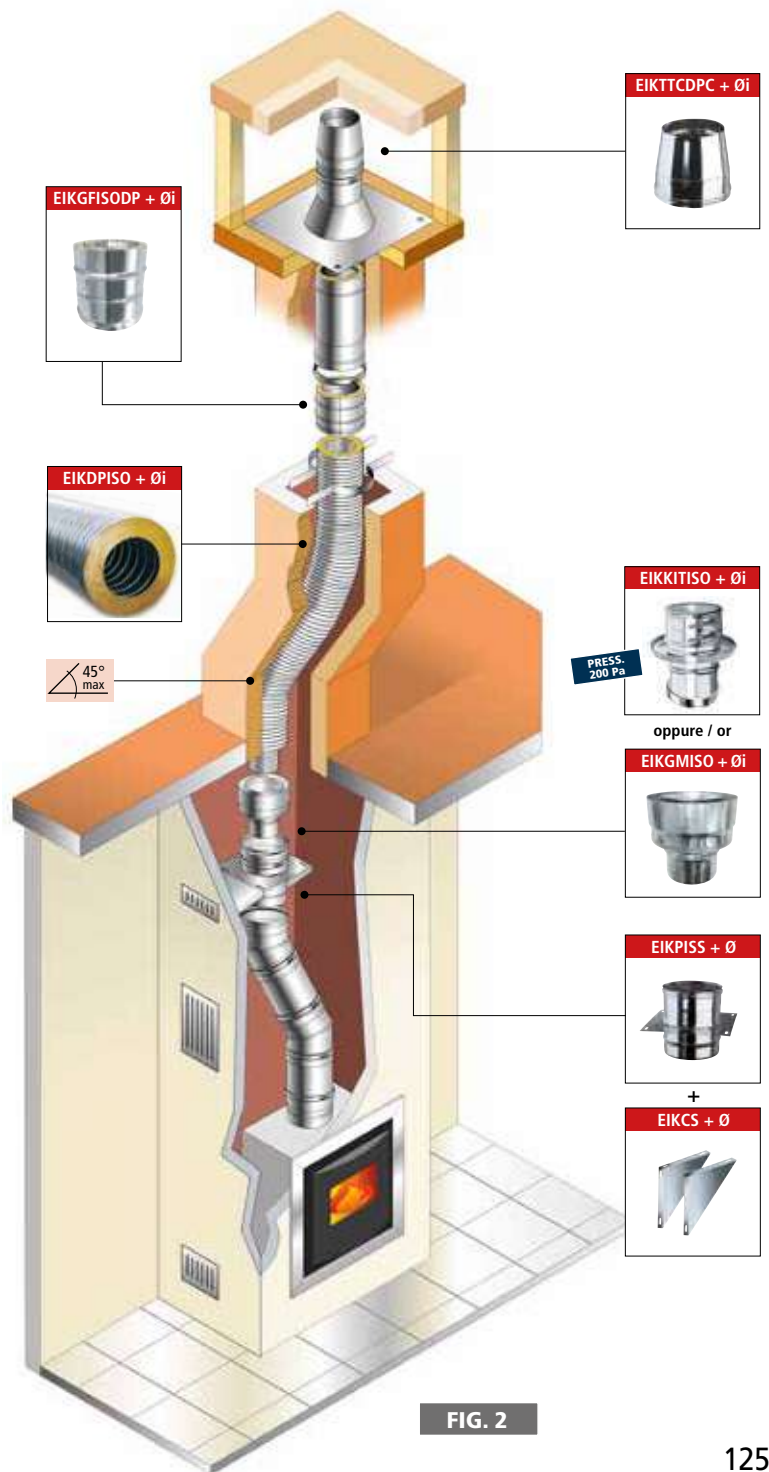

FIG. 2

FLESSIBILE ISOLATO POLICOMBUSTIBILE

SENZA PONTI TERMICI FINO A 30 m

- Parete interna doppia parete liscia INOX AISI 316L
- Parete esterna monoparete INOX AISI 304
- Isolamento 25 mm di lana di roccia ad alta densità
 - Semplice da utilizzare
 - Mantiene perfettamente la temperatura grazie all'isolante
 - Limita i rischi da accumulo di fuliggine
 - Ostacola la formazione di condensa nel condotto
 - Migliora il rendimento dell'apparecchio
 - Facilita il tiraggio del camino
- Il costo di installazione è ridottissimo: essendo pre-coibentato non necessita di ulteriore lavoro di assemblaggio tra il tubo flex e gli isolanti, che avviene generalmente in cantiere a cura dell'installatore

INSULATED FLEXIBLE LINER - POLYCOMBUSTIBLE

WITHOUT THERMAL BRIDGES UP TO 30 m

- Inner pipe: double wall with smooth inner surface in stainless steel AISI 316L
- Outer wall: single wall in stainless steel AISI 304
- Insulation: high density mineral wool 25 mm thickness
 - Easy to use
 - It keeps the temperature perfectly thanks to the insulation
 - It limits the risk of accumulation of soot
 - It hinders the formation of condensation inside the duct
 - It improves the performance of the appliance
- It facilitates the chimney draft
- Reduced costs for the installation: as ISOFLEX is pre-insulated it does not require any further manual work between the flex tube and the insulating material, which generally is done on site by the installer



	Øi	Ø 80	Ø 100	Ø 130	Ø 150	Ø 180
	Øe	Ø 136	Ø 156	Ø 186	Ø 206	Ø 236
LUNGH. ROTOLI STANDARD IMBALLO DISPENSER / LENGTH COILS STANDARD DISPENSER PACKAGING		30 m	30 m	25 m	20 m	Non disponibile Not available
LUNGH. ROTOLI STANDARD IMBALLO PLASTICA / LENGTH COILS STANDARD PLASTIC PACKAGING		30 m	30 m	30 m	20 m	20 m
LUNGH. SU RICHIESTA: METRI FINO A... LENGTH ON REQUEST: METERS UNTILL TO...		30 m	30 m	30 m	20 m	20 m
PESI / POIDS kg/ml		2,3	2,8	3,3	3,8	4,2

► Flessibile coibentato - Insulated flexible liner

CODICE	EIKDPIS0080	EIKDPIS0100	EIKDPIS0130	EIKDPIS0150	EIKDPIS0180
Øi	Ø 80	Ø 100	Ø 130	Ø 150	Ø 180

► Giunto flex rigido maschio - Flexadapter to rigid male

CODICE	EIKGMIS0080	EIKGMIS0100	EIKGMIS0130	EIKGMIS0150	EIKGMIS0180

► Giunto flex rigido femmina con invito interno anticondensa - Flexadapter to rigid female with condensate diverter

CODICE	EIKMXIS0080	EIKMXIS0100	EIKMXIS0130	EIKMXIS0150	EIKMXIS0180

► Giunto flex rigido femmina coibentato - Insulated flexadapter to rigid female

CODICE	EIKGFISODP080	EIKGFISODP100	EIKGFISODP130	EIKGFISODP150	EIKGFISODP180

► Giunto flex 200 Pa rigido maschio con fascetta di chiusura - Flexadapter 200 Pa to rigid male with locking band

CODICE	EIKKITIS0080	EIKKITIS0100	#	#	#

► Fascetta anti-intemperie - Storm collar

CODICE	EIKFAPS2S080	EIKFAPS2S100	EIKFAPS2S130	EIKFAPS2S150	EIKFAPS2S180

► Piastra terminale - Top plate

CODICE	EIKPTFLEX130	EIKPTFLEX150	EIKPTFLEX180	EIKPTFLEX200	EIKPTFLEX220

► Collare di bloccaggio rinforzato - Reinforced top clamp

CODICE	EIKCBFLEXRIN130	EIKCBFLEXRIN150	EIKCBFLEXRIN180	EIKCBFLEXRIN200	EIKCBFLEXRIN230

► Cappello cinese con fascetta di bloccaggio - Rain cap with locking band

CODICE	EIKCCMONO080	EIKCCMONO100	EIKCCMONO130	EIKCCMONO150	EIKCCMONO180

► Terminale anti-intemperie - Anti downdraught terminal

CODICE	EIKTAPSS080	EIKTAPSS100	EIKTAPSS130	EIKTAPSS150	EIKTAPSS180

► Terminale tronco conico - Venturi cone terminal

CODICE	EIKTTCDPC080	EIKTTCDPC100	EIKTTCDPC130	EIKTTCDPC150	EIKTTCDPC180

► Piastra intermedia - Intermediate anchor plate

CODICE	EIKPISS080	EIKPISS100	EIKPISS130	EIKPISS150	EIKPISS180

► Coppia supporti - Cantilever brackets (pair)

CODICE	EIKCS080	EIKCS100	EIKCS130	EIKCS150	EIKCS180

Per ulteriori informazioni (imballi, metrature, ecc.) contattare il nostro ufficio commerciale

For further information (packages, meters, etc.) contact your sales office

Non disponibile
Not available

FLESSIBILE COIBENTATO - INSULATED FLEXIBLE LINER

NEW!

KIT 7 - 9 - 11 m

EIKKITiso7

EIKKITiso9



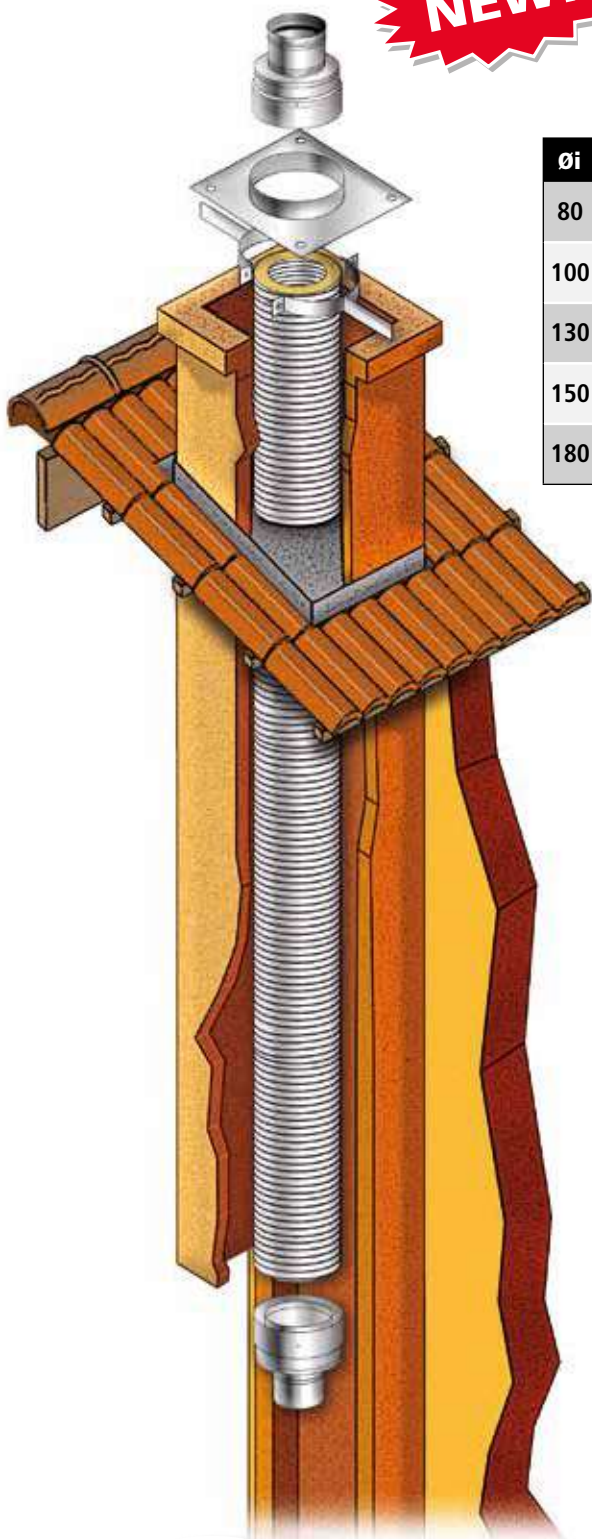

EIKITiso11

Øi	m	COD.	m	COD.	m	COD.
80	7	EIKKITISO708	9	EIKKITISO908	11	EIKKITISO1108
100	7	EIKKITISO710	9	EIKKITISO910	11	EIKKITISO1110
130	7	EIKKITISO713	9	EIKKITISO913	11	EIKKITISO1113
150	7	EIKKITISO715	9	EIKKITISO915	11	EIKKITISO1115
180	7	EIKKITISO718	9	EIKKITISO918	11	EIKKITISO1118







EIKKITiso7



CONTIENE / CONTAINS	
 1	Rotolo 7 metri Coil 7 meters
 1	Piastra per flex Top plate for flexible pipe
 1	Collare di bloccaggio per flex Top clamp for flexible pipe
 1	Giunto isoflex rigido maschio Insulated flexadapter to rigid male
 1	Giunto isoflex rigido femmina Insulated flexadapter to rigid female





EIKKITiso9



CONTIENE / CONTAINS	
 1	Rotolo 9 metri Coil 9 meters
 1	Piastra per flex Top plate for flexible pipe
 1	Collare di bloccaggio per flex Top clamp for flexible pipe
 1	Giunto isoflex rigido maschio Insulated flexadapter to rigid male
 1	Giunto isoflex rigido femmina Insulated flexadapter to rigid female

EIKKITiso11



CONTIENE / CONTAINS	
 1	Rotolo 11 metri Coil 11 meters
 1	Piastra per flex Top plate for flexible pipe
 1	Collare di bloccaggio per flex Top clamp for flexible pipe
 1	Giunto isoflex rigido maschio Insulated flexadapter to rigid male
 1	Giunto isoflex rigido femmina Insulated flexadapter to rigid female

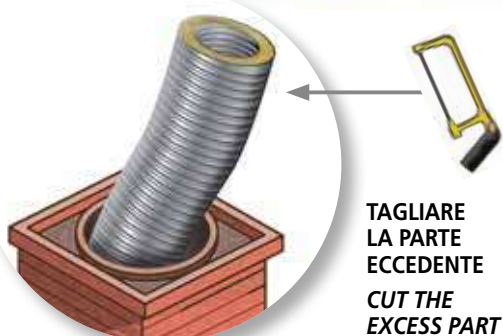

TAGLIARE
LA PARTE
ECCEDENTE
CUT THE
EXCESS PART

